

Cascade Corporate Center
Worthington, OH 43085

For Lease



Professional office suites perfectly suited to your business

Cascade I: 130 E Wilson Bridge Rd
Cascade II: 150 E Wilson Bridge Rd
Cascade V: 250 E Wilson Bridge Rd

Lease Rates:
\$16.95 - \$21.95 psf Gross

Available Space:
798 RSF to 6,200 RSF

- Excellent Worthington location in close proximity to restaurants, services and shopping
- Convenient access to I-270, I-71, SR 315 and SR 23
- Lighted parking (4.1/1,000), vending area with seating, outdoor patio, storage, 24/7 key card access
- Athletic club on site offering handball/racquetball courts, exercise/cardio equipment, lockers, and sauna/showers
- Conference center for tenant use (accommodates 30)



Brad Kitchen, SIOR
614.545.2155
bkitchen@AlterraRE.com

Alterra Real Estate
614.365.9000
www.AltterraRE.com

Cascade Corporate Center

Available Space for Lease

Cascade I - 130 E Wilson Bridge Road

Floor	RSF	Comments
Terrace	1,225	
Second	3,085	
Third	798	
	1,142*	
	1,525*	*Can be combined for total of 2,667 SF
	1,861	

Cascade II - 150 E Wilson Bridge Road

Floor	RSF	Comments
Terrace	996*	
	1,188*	*Can be combined for total of 2,184 SF
	6,200	
Second	2,047	
	1,536**	
	1,555**	**Can be combined for total of 3,091 SF

Cascade V - 250 E Wilson Bridge Road

Floor	RSF	Comments
First	3,965	
	1,914	
Second	2,883	



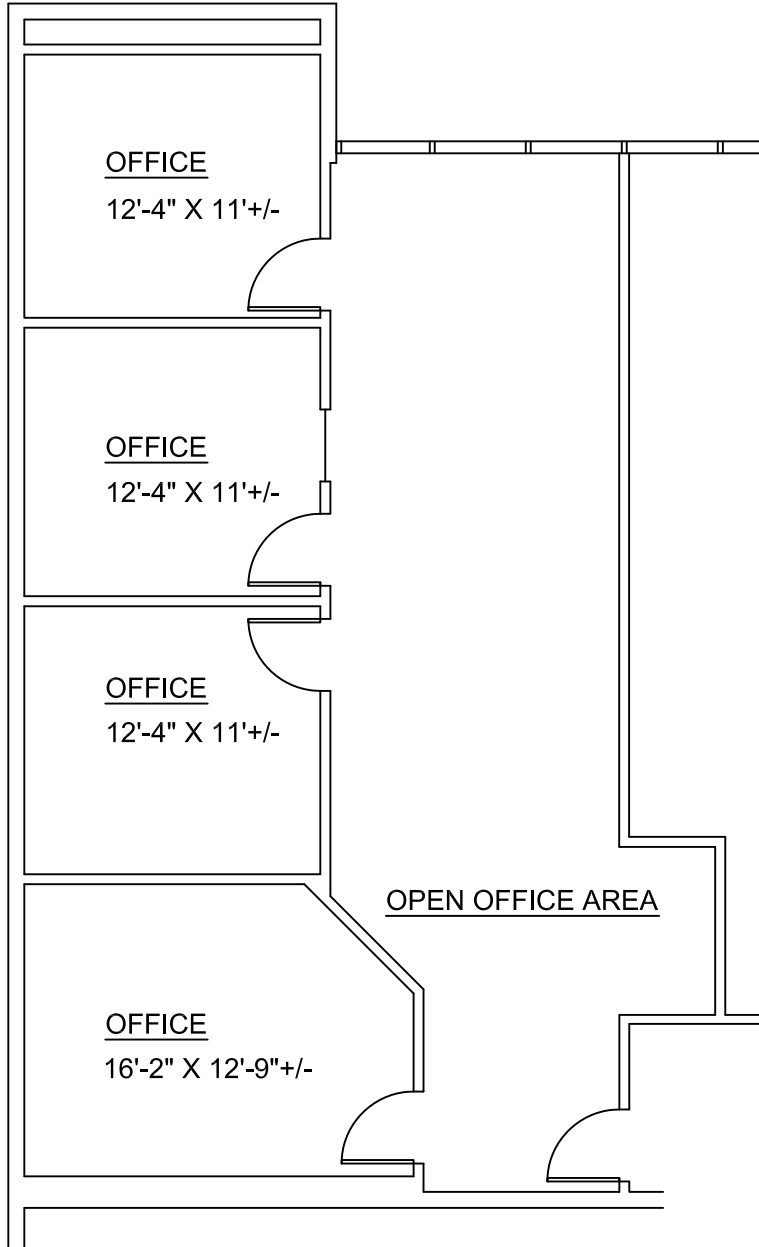

Cascade I - Suite 75

1,225 Sq. Ft. Scale 1/8" = 1' - 0"

Cascade Corporate Center

130 East Wilson Bridge Road - Terrace Level
 Worthington, Ohio

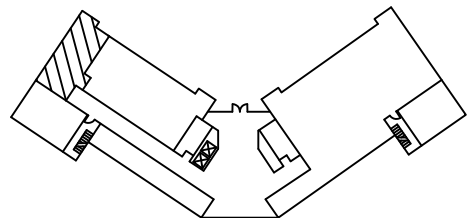

Terrace Level Key Plan

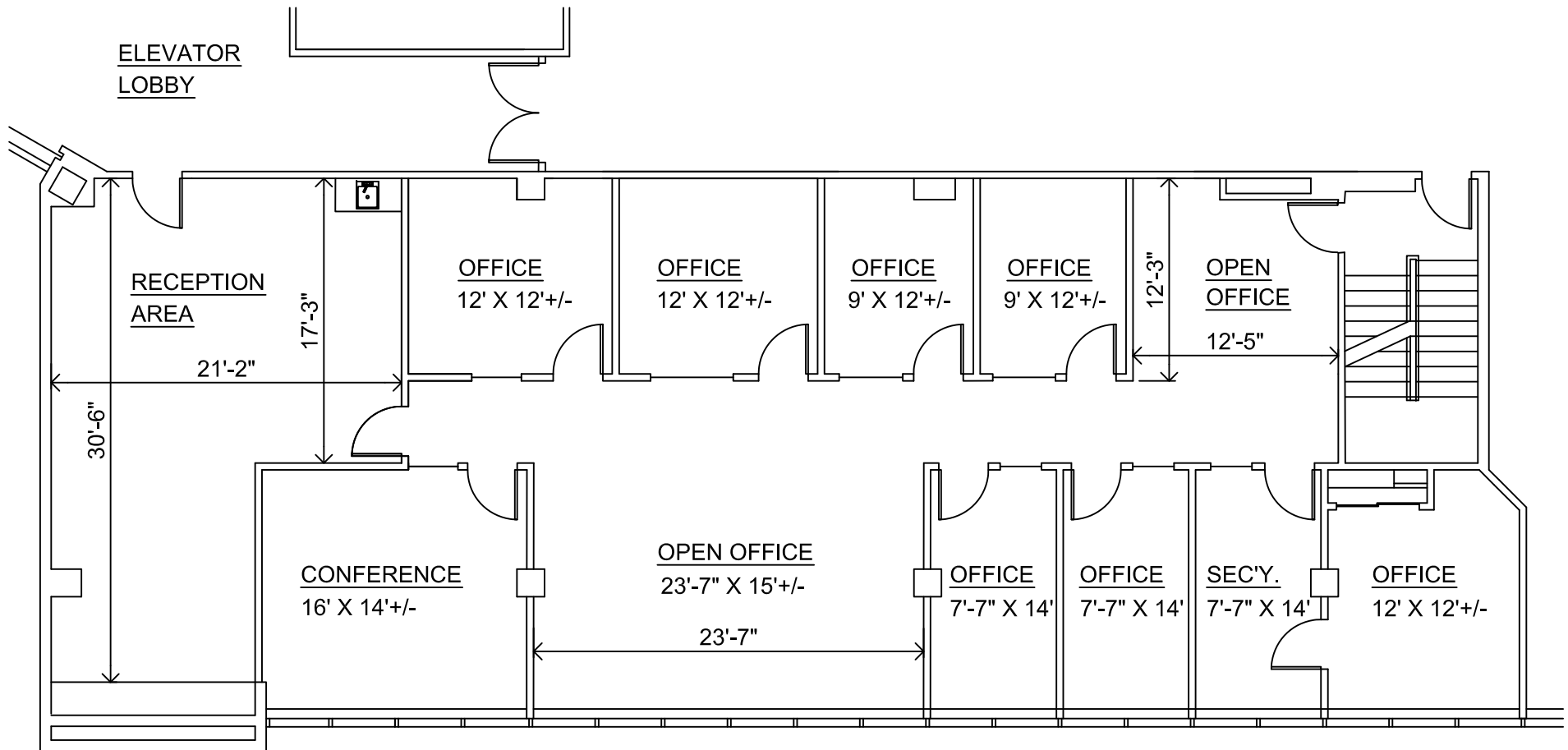

Cascade I - Suite 210

3,085 Sq. Ft. Total Available Not to Scale

Cascade Corporate Center

130 East Wilson Bridge Road - Second Floor
Worthington, Ohio

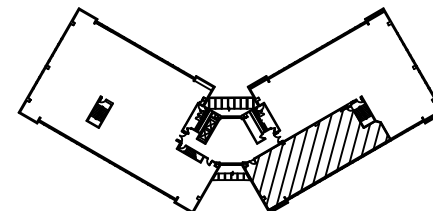

Second Floor Key Plan

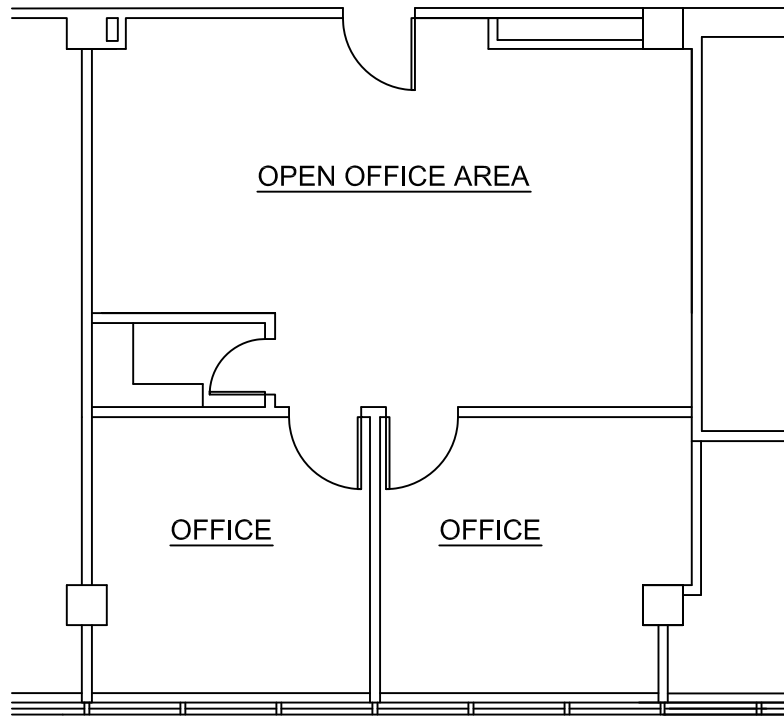

Cascade I - Suite 303

Cascade Corporate Center

130 East Wilson Bridge Road - Third Floor
Worthington, Ohio

798 Sq. Ft. Rentable Area Scale 1/8" = 1' - 0"

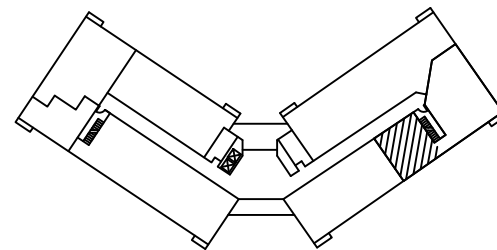

TOTAL COMBINED SUITES 308-310 - 2,667 SF RENTABLE AREA PER LEASE

SUITE 310

1,525 RSF

SUITE 308

1,142 RSF

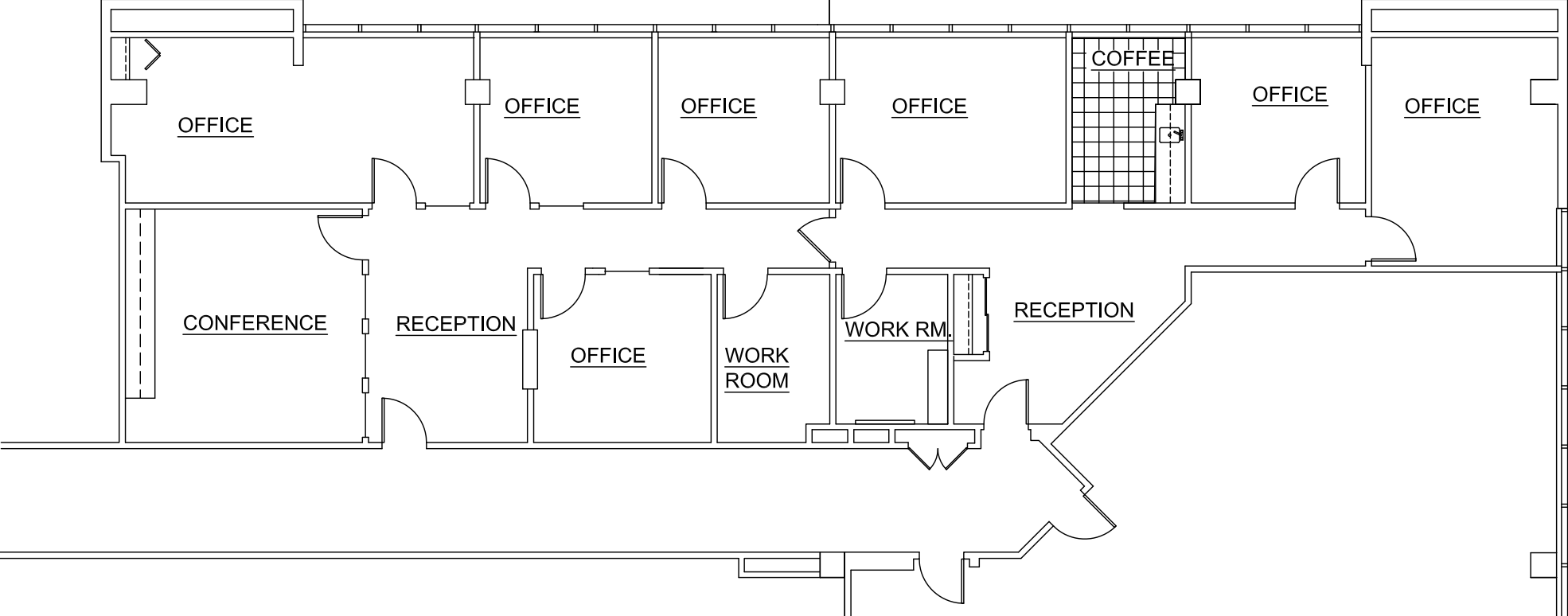

CASCADE I - S.308-310

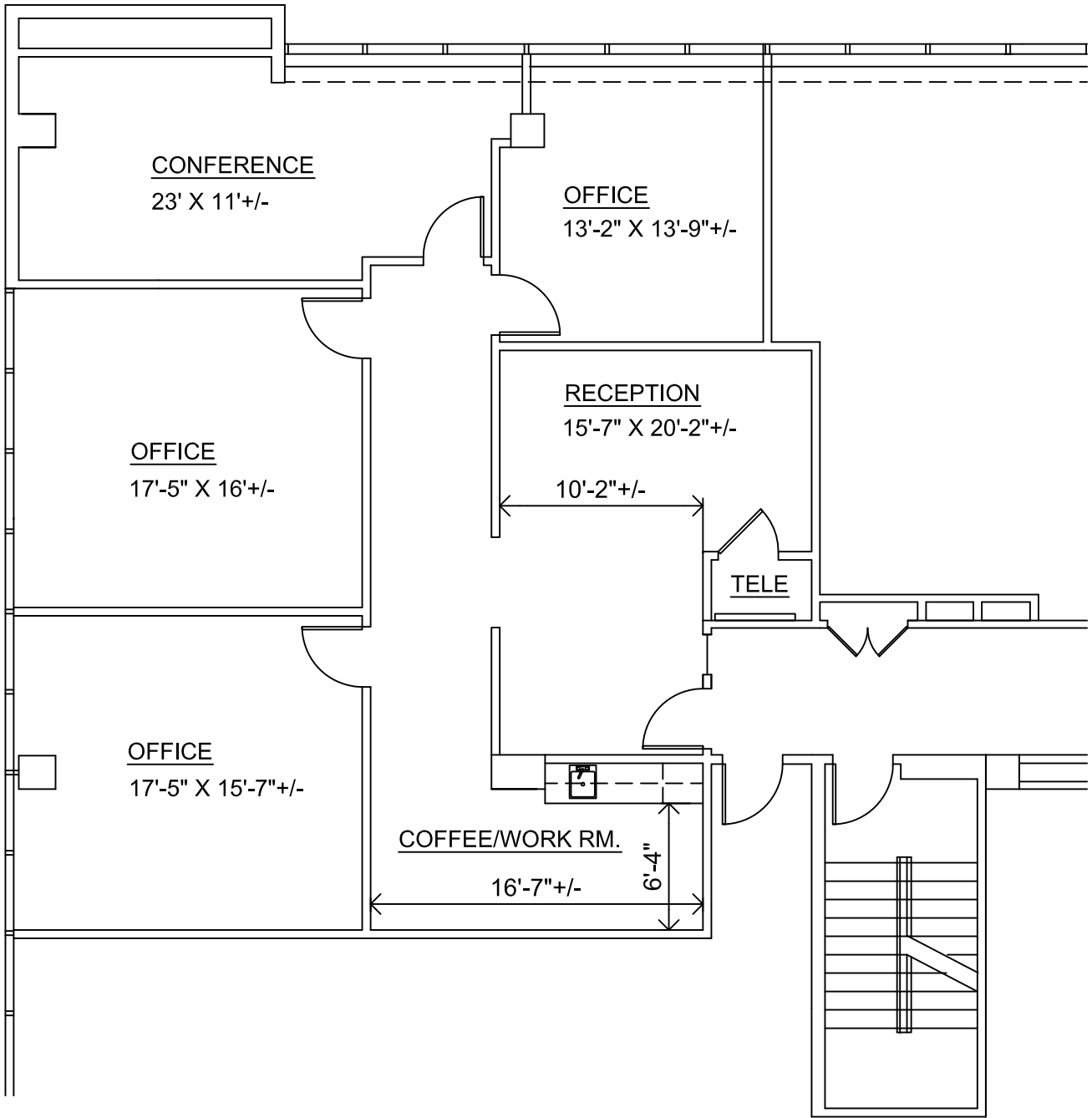

Cascade I - Suite 327

1,861 Sq. Ft. Scale 1/8" = 1' - 0"

Cascade Corporate Center

130 East Wilson Bridge Road - Third Floor
 Worthington, Ohio

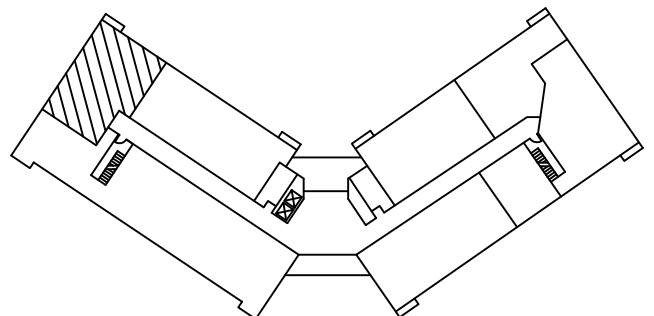

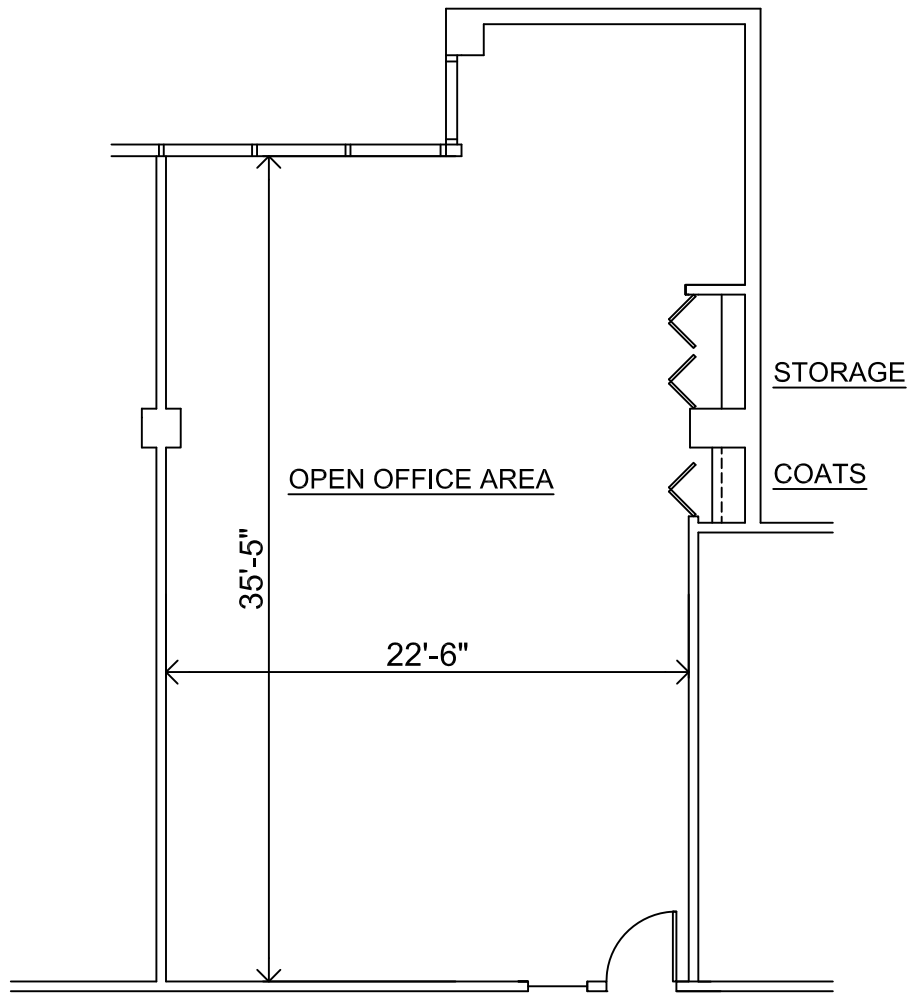

Cascade II - Suite 50 Available

996 Sq. Ft. Scale 1/8" = 1' - 0"

Cascade Corporate Center

150 East Wilson Bridge Road - Terrace Level
 Worthington, Ohio

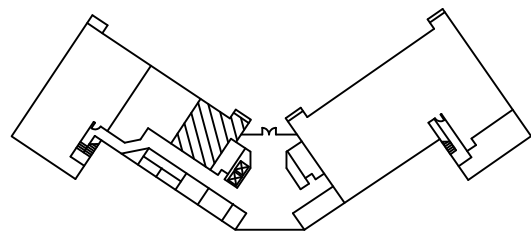

Terrace Level Key Plan

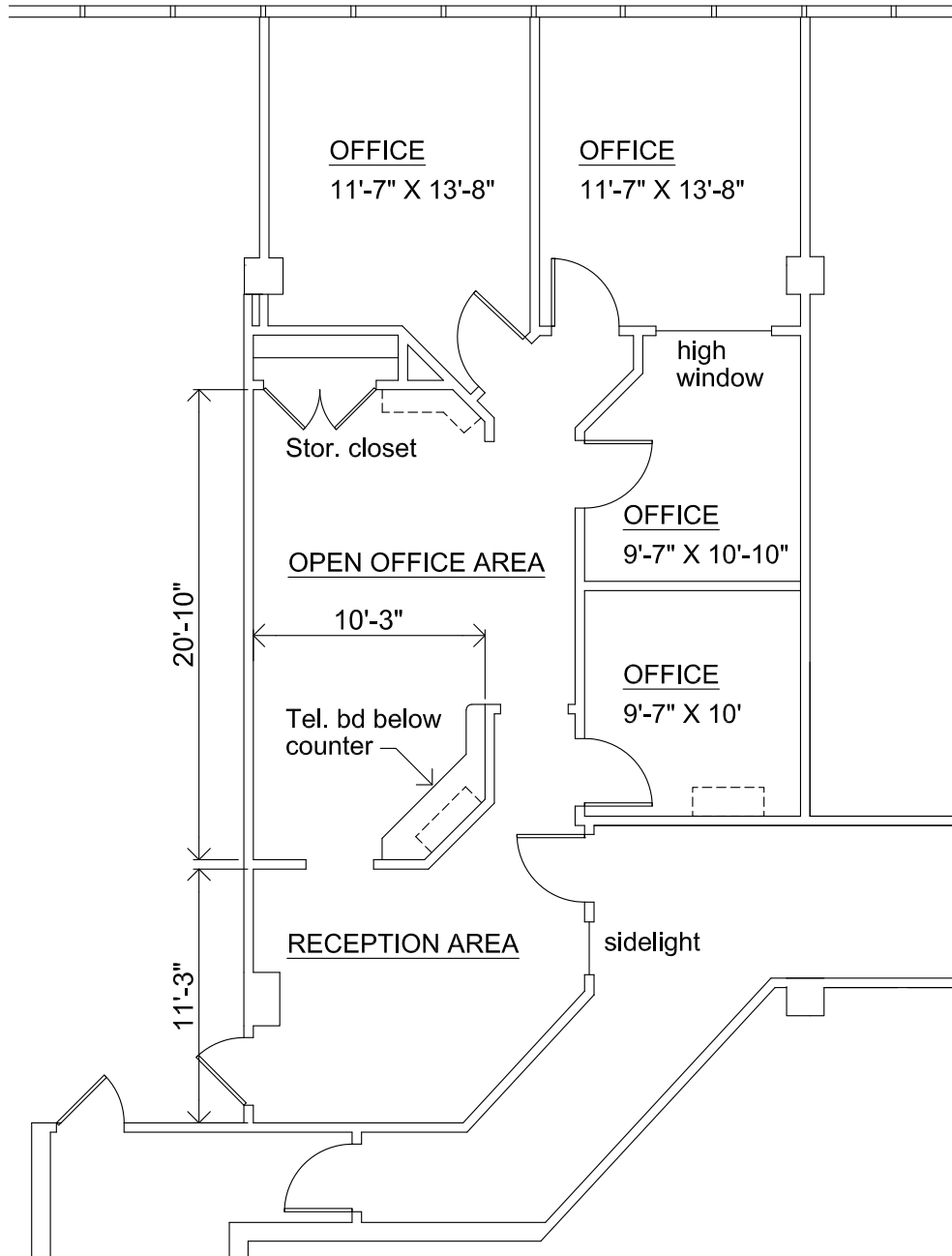

Cascade II - Suite 55

1,188 Sq. Ft. Scale 1/8" = 1' - 0"

Cascade Corporate Center

150 East Wilson Bridge Road - Terrace Level
 Worthington, Ohio

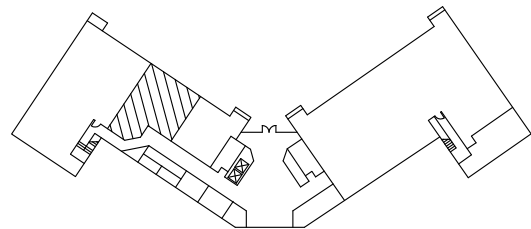

Terrace Level Key Plan

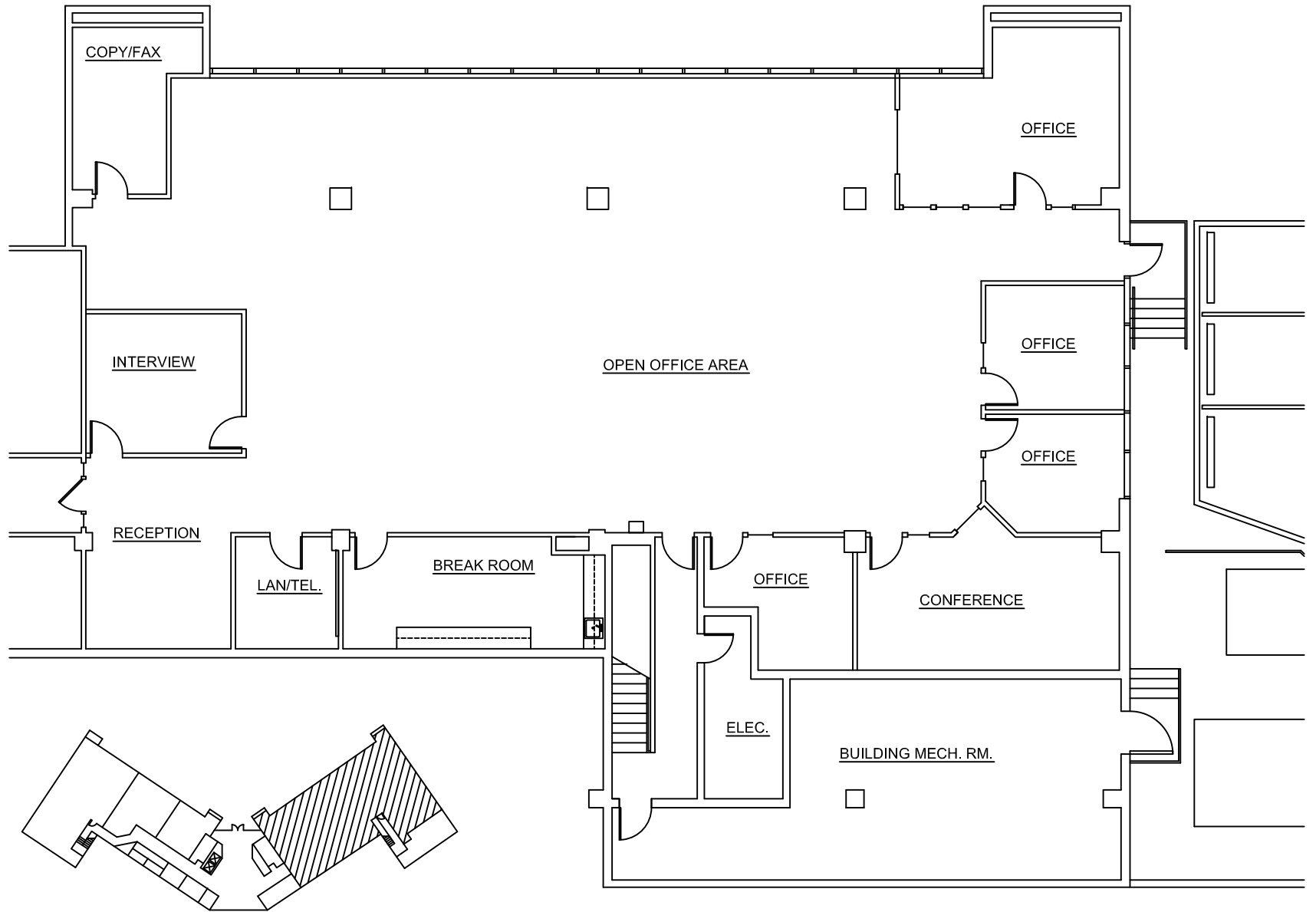

CASCADE II - SUITE 75

6,200 RSF

150 E Wilson Bridge Road
Suite 215 2,047 SF

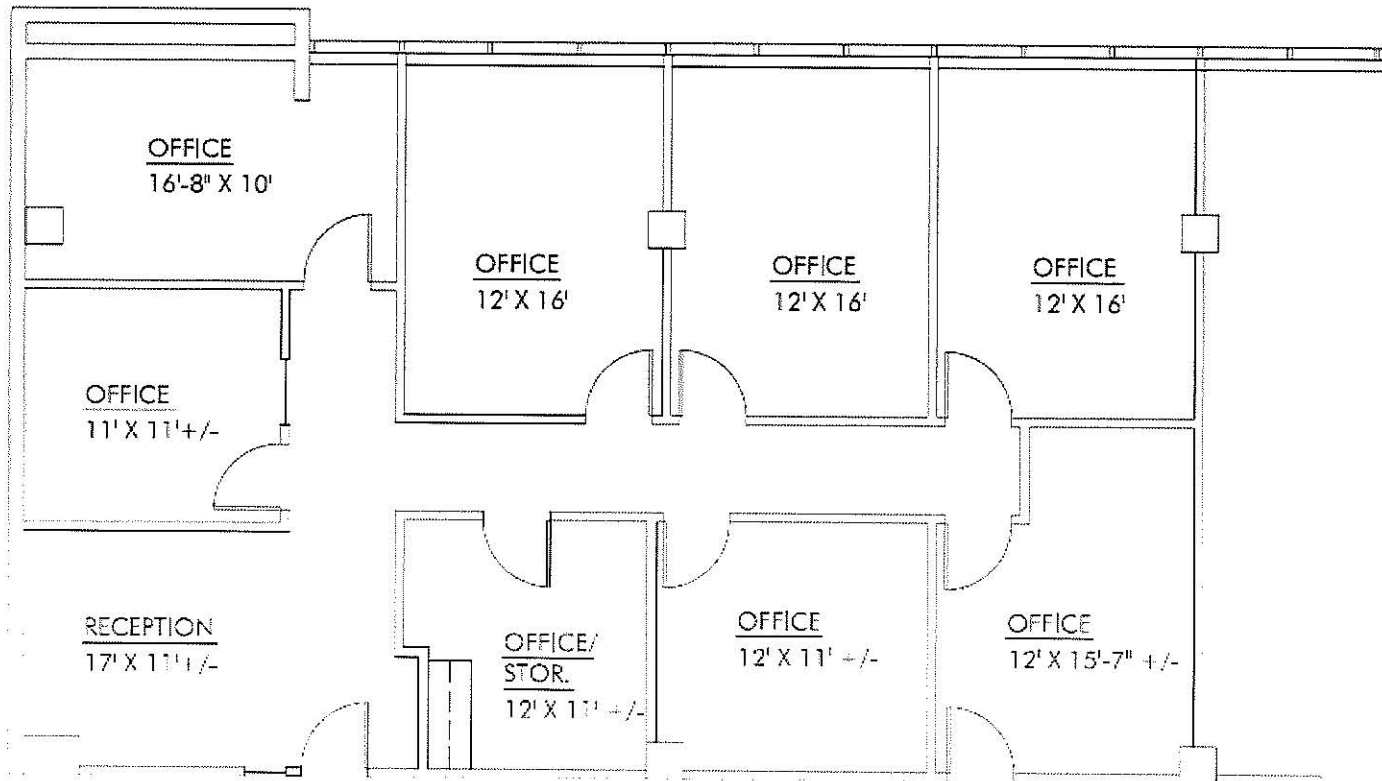

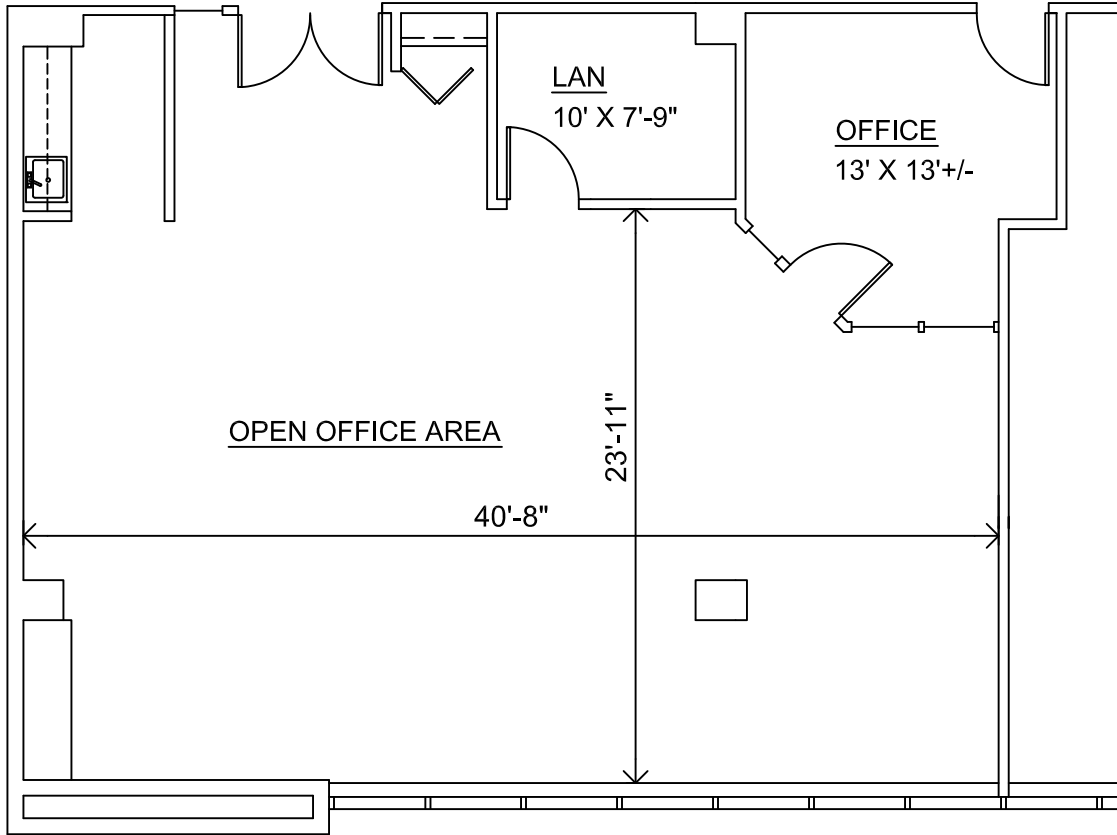

Cascade II - Suite 235

1,536 Sq. Ft. Scale 1/8" = 1' - 0"

Cascade Corporate Center

150 East Wilson Bridge Road - Second Floor
 Worthington, Ohio

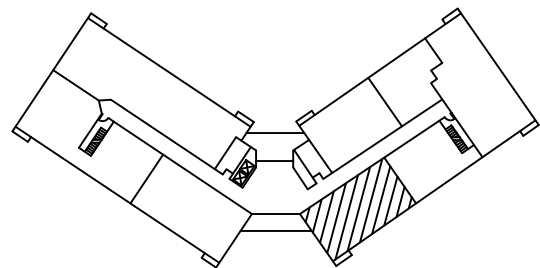

Second Floor Key Plan

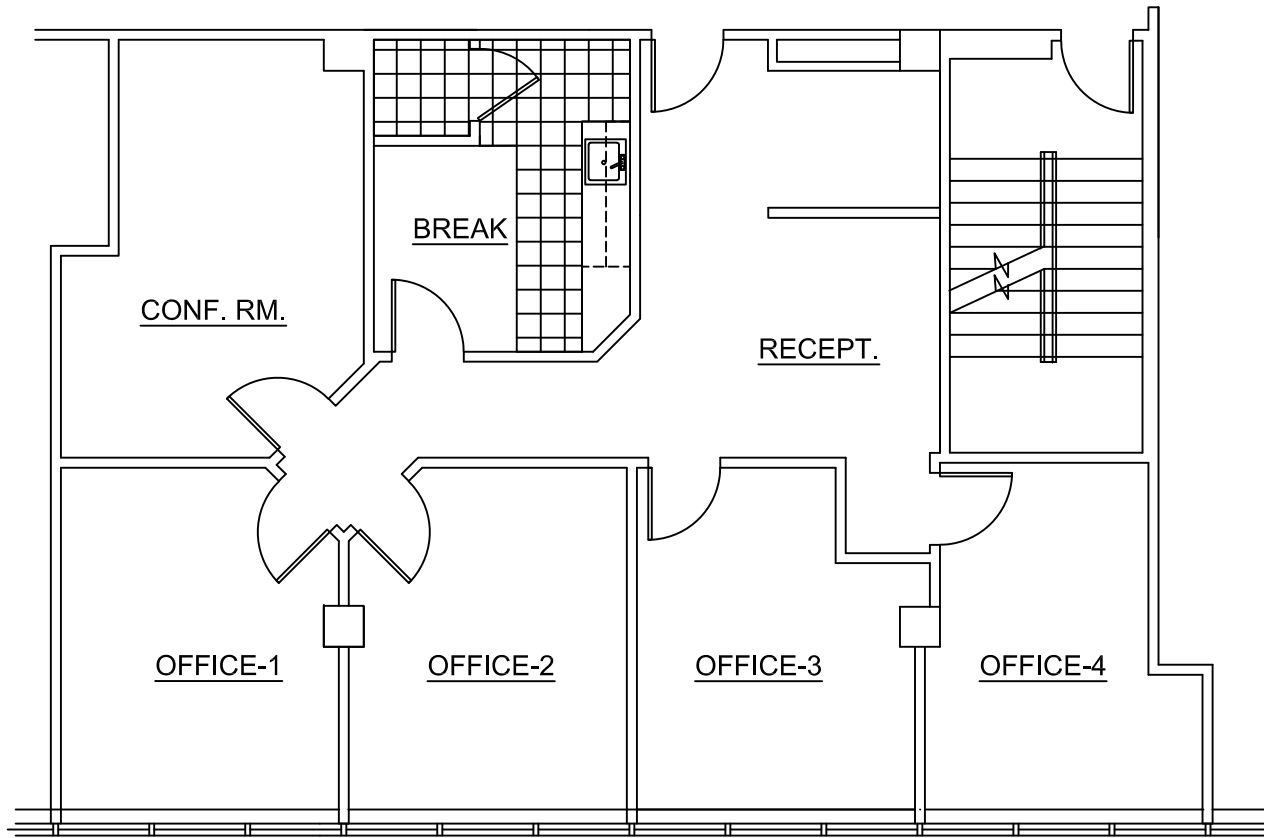

SUITE 232

Cascade II
 150 East Wilson Bridge Road - Second Floor
 Worthington, Ohio

Scale 1/8" = 1' - 0"

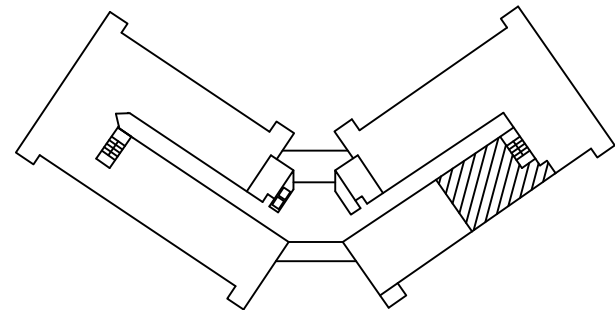
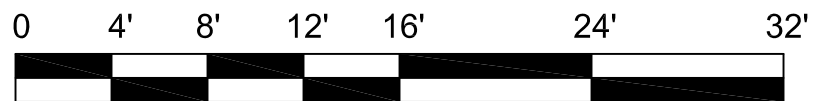

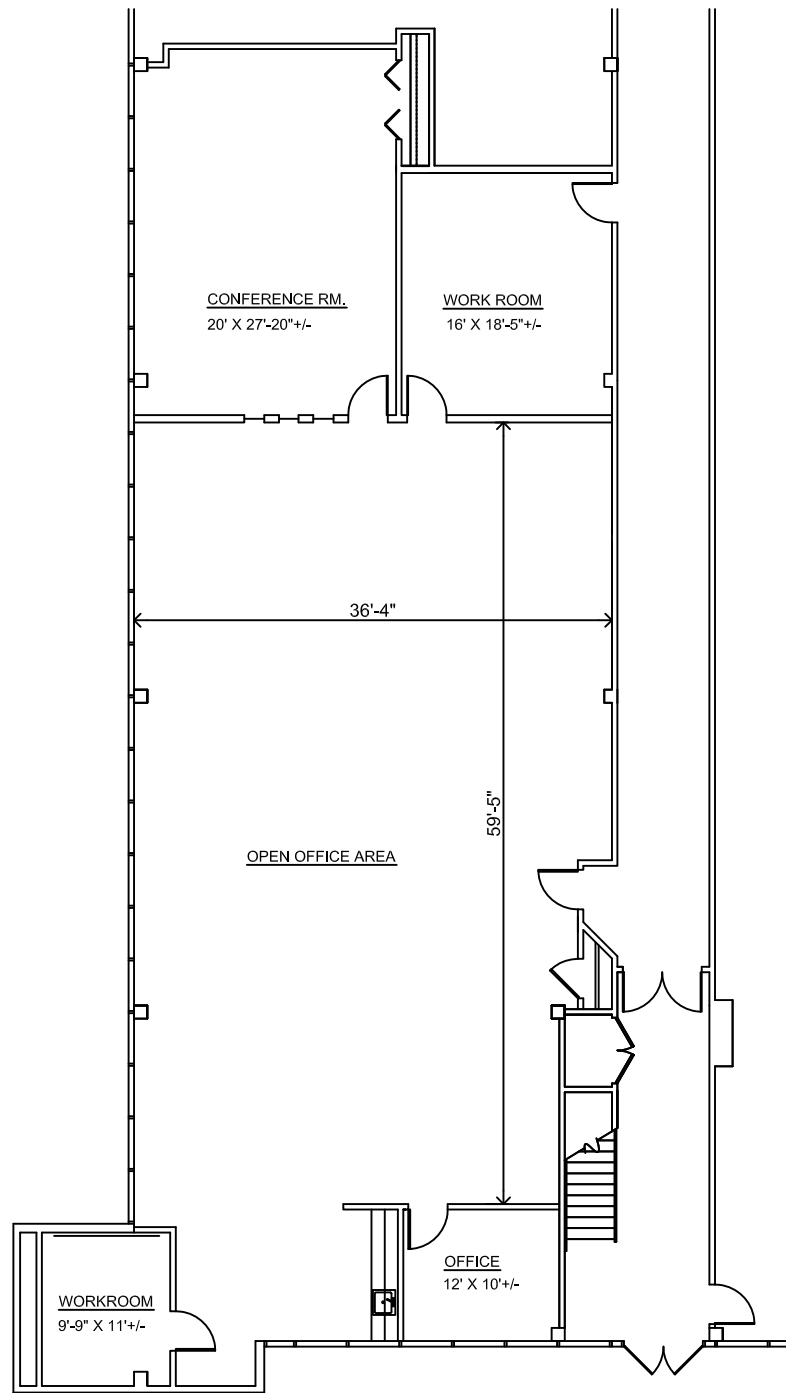

Cascade V - Suite 120

3,965 Sq. Ft. Not to Scale

Cascade Corporate Center

250 East Wilson Bridge Road - First Floor
 Worthington, Ohio

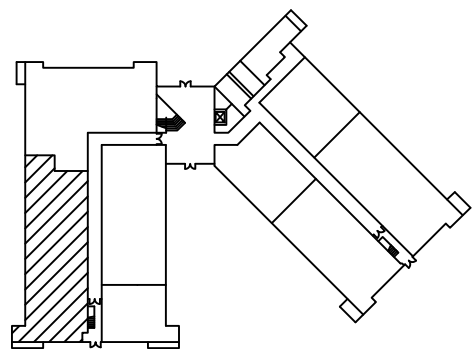

First Floor Plan

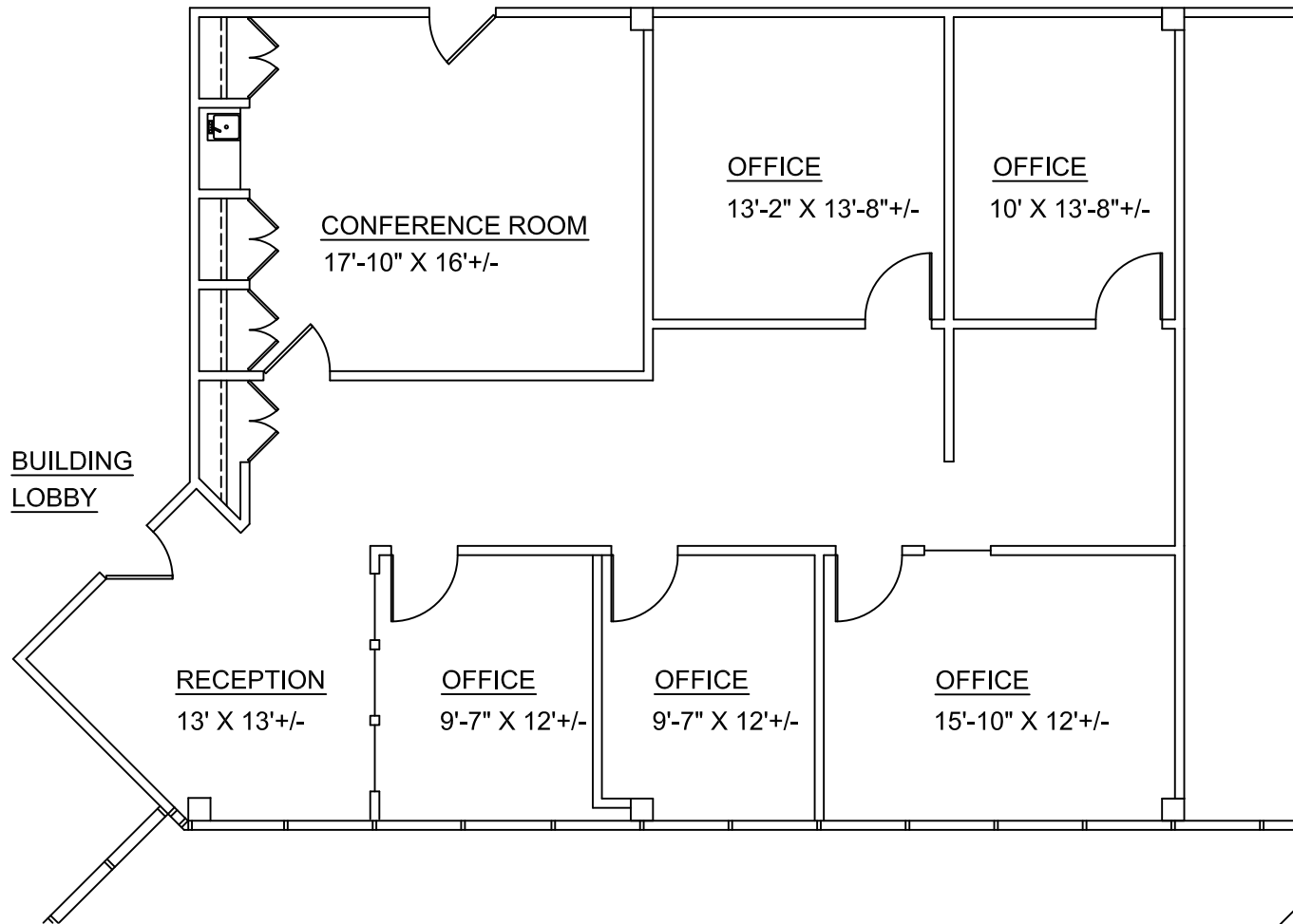

Cascade V - Suite 150

1,914 Sq. Ft. Scale 1/8" = 1' - 0"

Cascade Corporate Center

250 East Wilson Bridge Road - Terrace Level
Worthington, Ohio

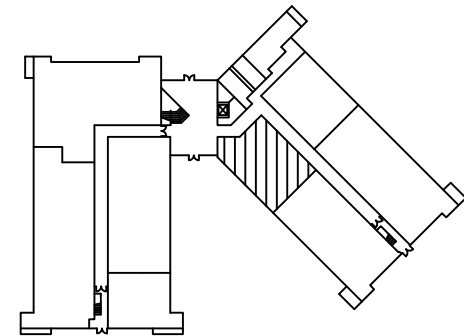

First Floor Key Plan

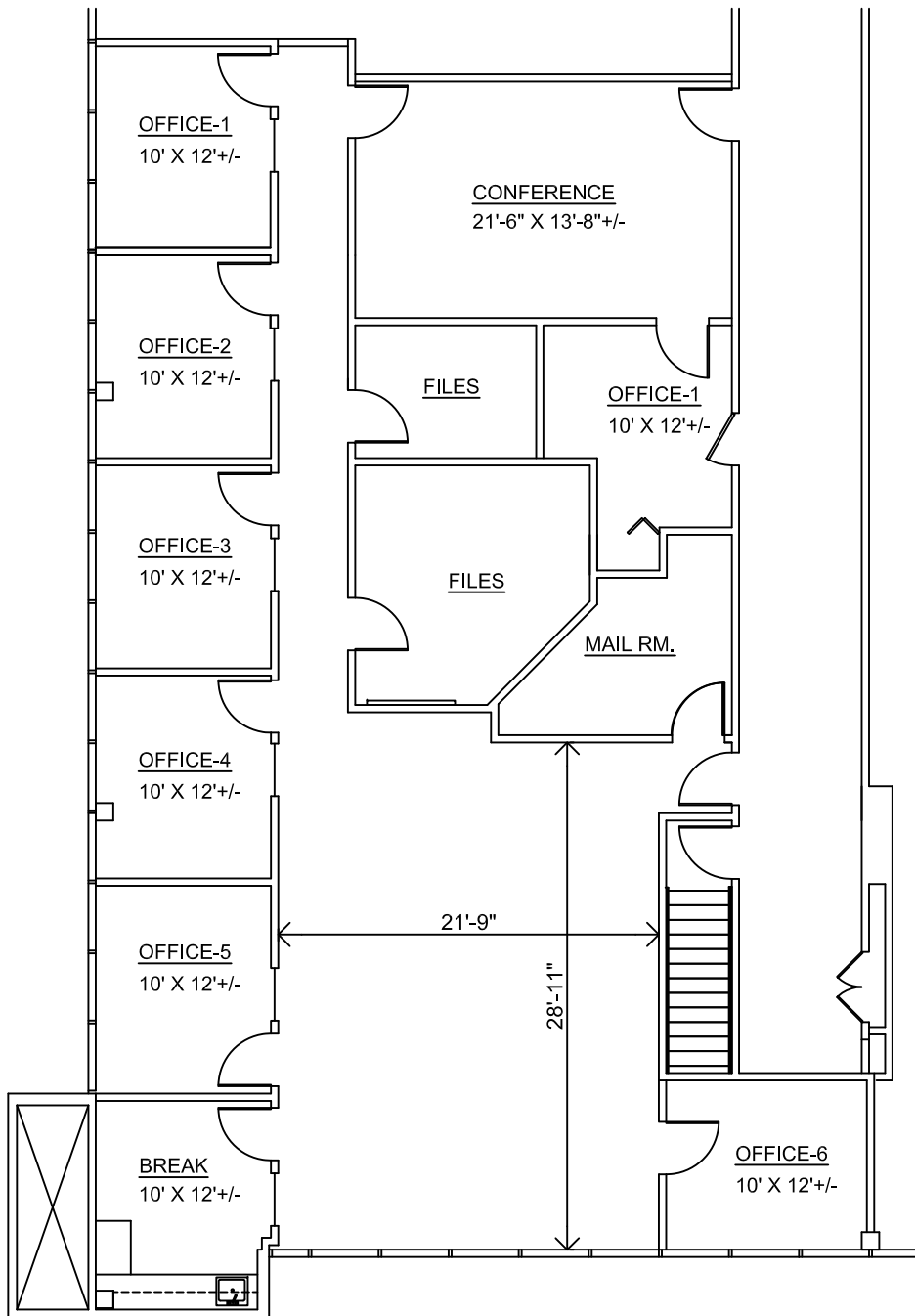

CASCADE V - SUITE 260
AVAILABLE SUITE
2,883 RSF

