

3700 Corporate Drive  
Columbus, OH 43228

For Lease



## Office space perfectly suited for your business

### Lease Rates:

\$7.95 - \$11.95 psf NNN

### Available Space:

1st Floor 2,072 sf - 14,503 sf

2nd Floor 1,715 sf - 16,250 sf

- Immediate occupancy
- Flexible floor plans
- Exterior signage available (monument & building)
- Recently updated common areas
- Wooded setting with walking path
- Located off of SR 161 with easy access to I-670, I-270 and I-71
- Convenient to Easton Town Center and John Glenn International Airport

All the contained information has been compiled from sources deemed to be reliable, but no representation is made as to the accuracy thereof and it is submitted subject to errors and omissions. Buyer is responsible for verifying the information contained herein. The submission is also subject to changes in price, rental or other conditions, prior sale, lease or financing or withdrawal without notice.



Jeff Rudicil (JR)  
614.545.2157  
jr@AlterraRE.com

Bradford L. Kitchen, SIOR  
614.545.2155  
bkitchen@AlterraRE.com

Alterra Real Estate  
614.365.9000  
www.AltterraRE.com

3700 Corporate Drive  
Columbus, OH 43228

# AVAILABLE SPACE 1st Floor

Suite	RSF	Comments
100	8,201	Located directly off 1st floor lobby. Can be combined with Ste 160 for 14,503 SF
110	2,946	6 offices incl corner office, conference room, break room. Can be combined with adjacent suites for up to total of 10,134 SF
120	5,299	
130	5,116	Can be combined with adjacent suites for up to total of 10,134 SF
145	2,072	5 offices, reception, break room, open area and work room. Can be combined with adjacent suites for up to total of 10,134 SF
160	6,302	Located directly off 1st floor lobby. Can be combined with Ste 100 for 14,503 SF

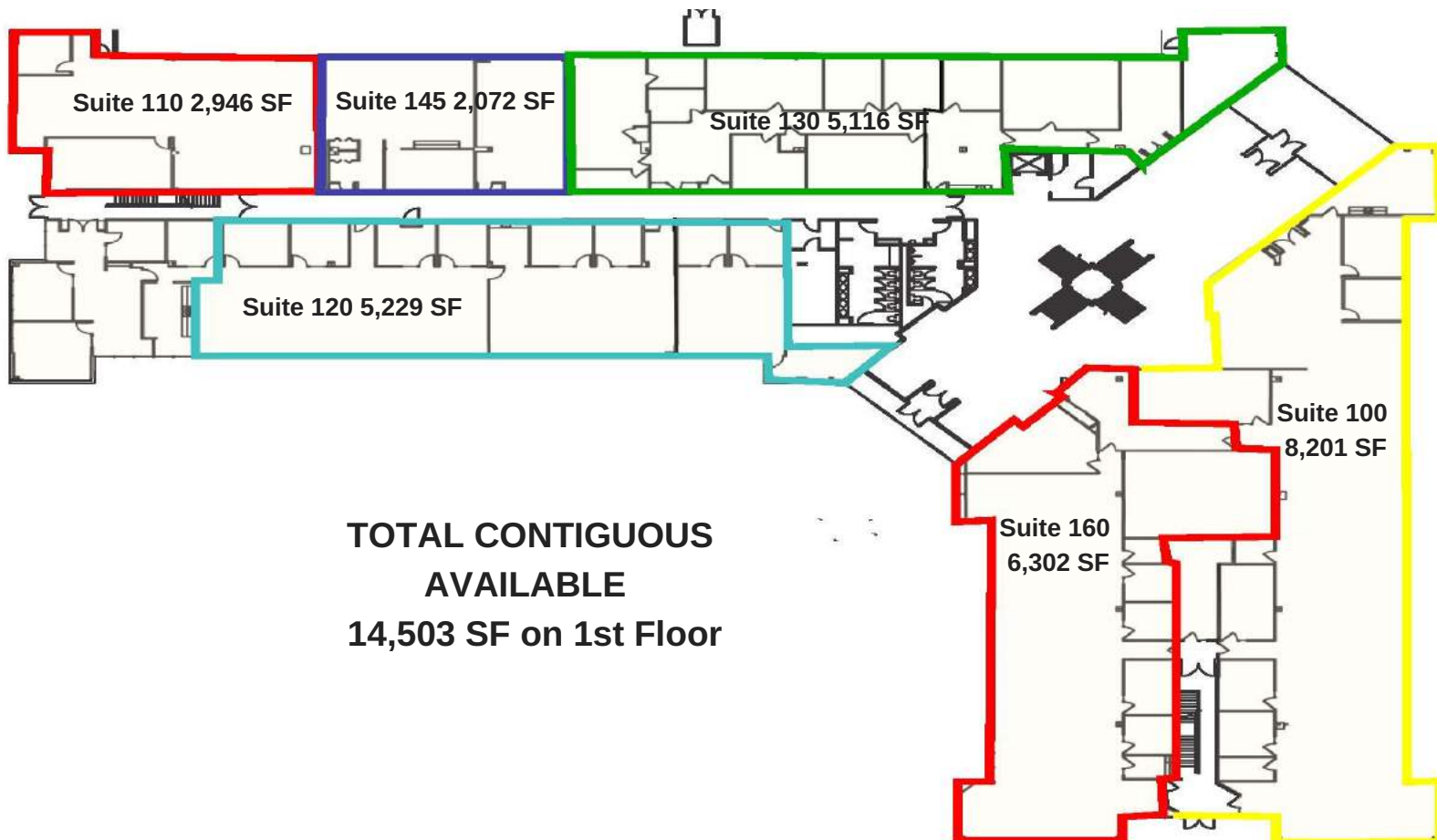

Jeff Rudicil (JR)  
614.545.2157  
jr@AlterraRE.com

Bradford L. Kitchen, SIOR  
614.545.2155  
bkitchen@AlterraRE.com

Alterra Real Estate  
614.365.9000  
www.AltterraRE.com

3700 Corporate Drive  
Columbus, OH 43228

# AVAILABLE SPACE 2nd Floor

Suite	RSF	Comments
200	14,535	Located off 2nd floor lobby; abundant windows, flexible floor plan; divisible. Can be combined with adjacent suite for 16,250 SF
210	1,715	Located off 2nd floor lobby; abundant windows. Can be combined with adjacent suite for 16,250 SF

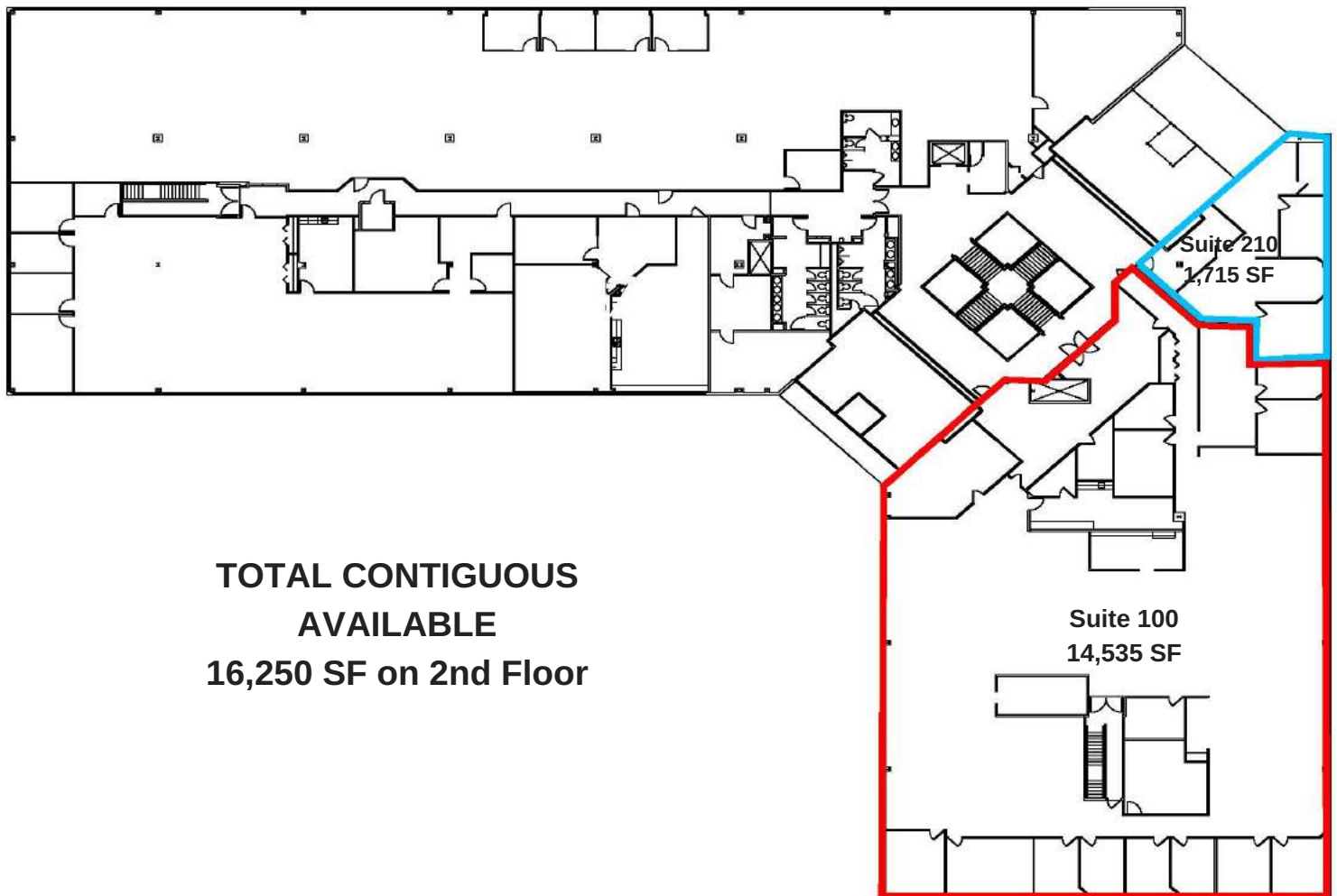

Jeff Rudicil (JR)  
614.545.2157  
jr@AlterraRE.com

Bradford L. Kitchen, SIOR  
614.545.2155  
bkitchen@AlterraRE.com

Alterra Real Estate  
614.365.9000  
www.AltterraRE.com

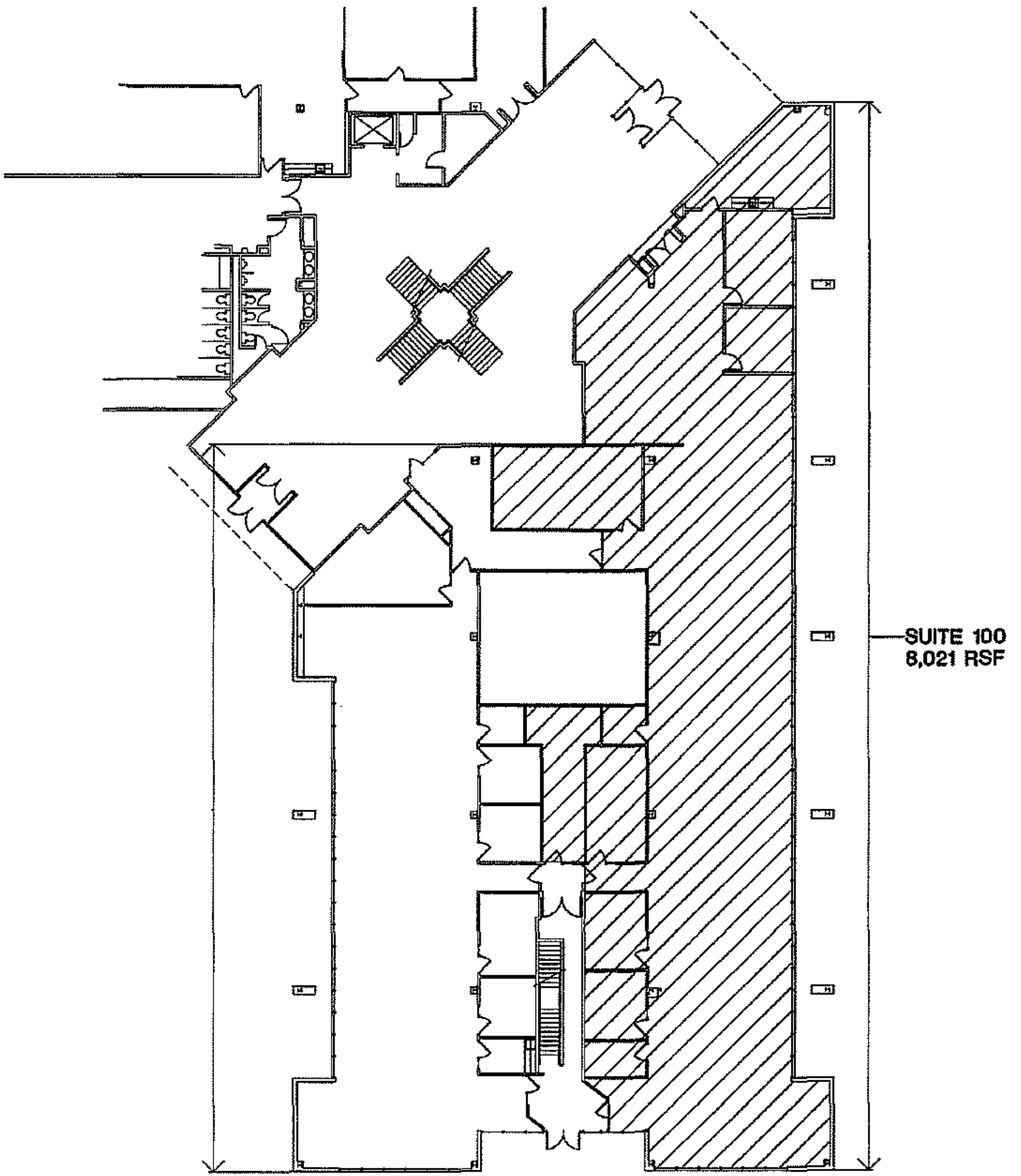

FIRST FLOOR - NEBC #5

Parking Area

Suite 110  
2,946 SF

Entrance/Exit

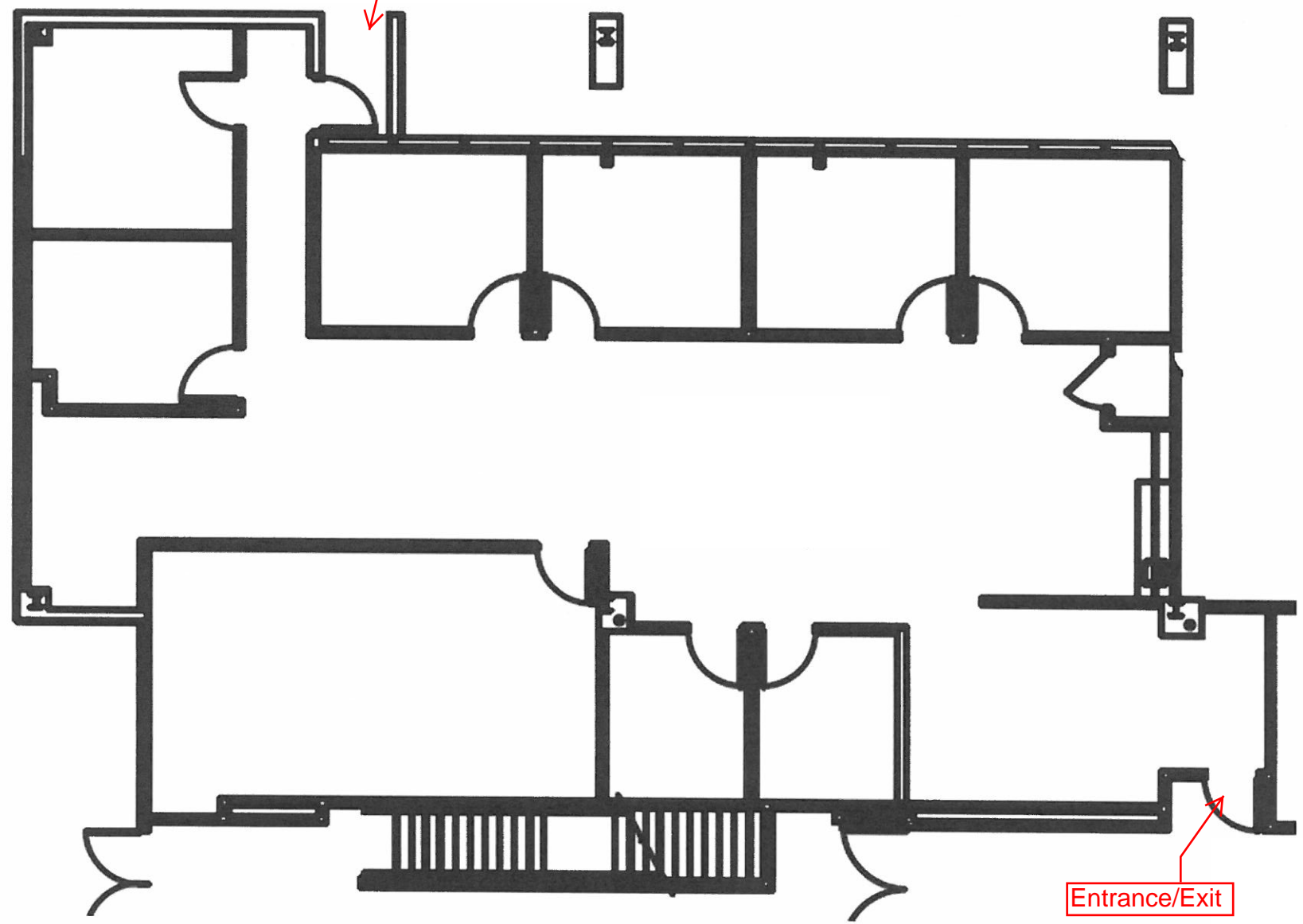

Entrance/Exit

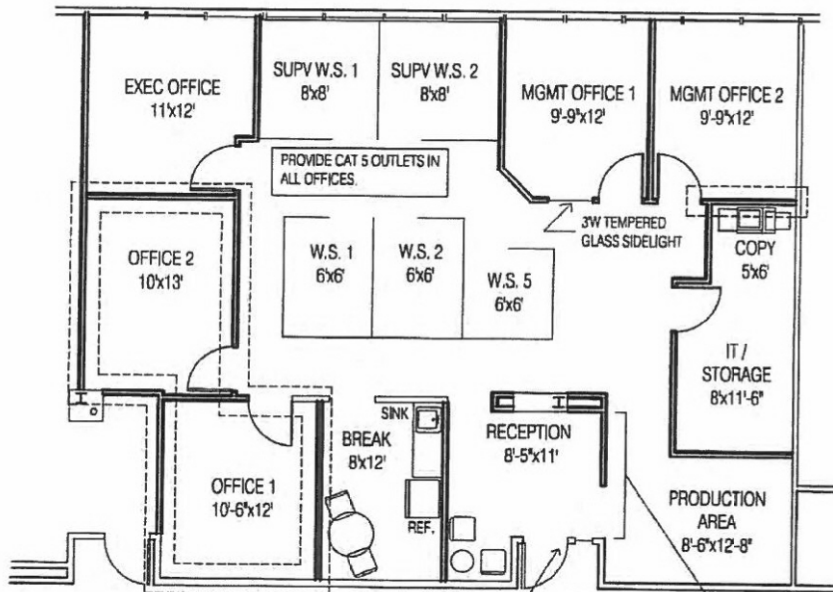

Suite 145  
2,072 SF

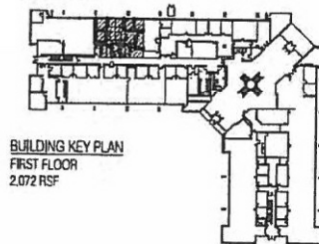



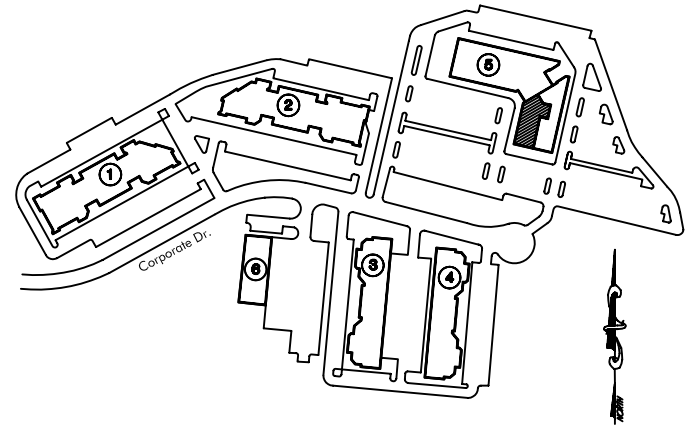
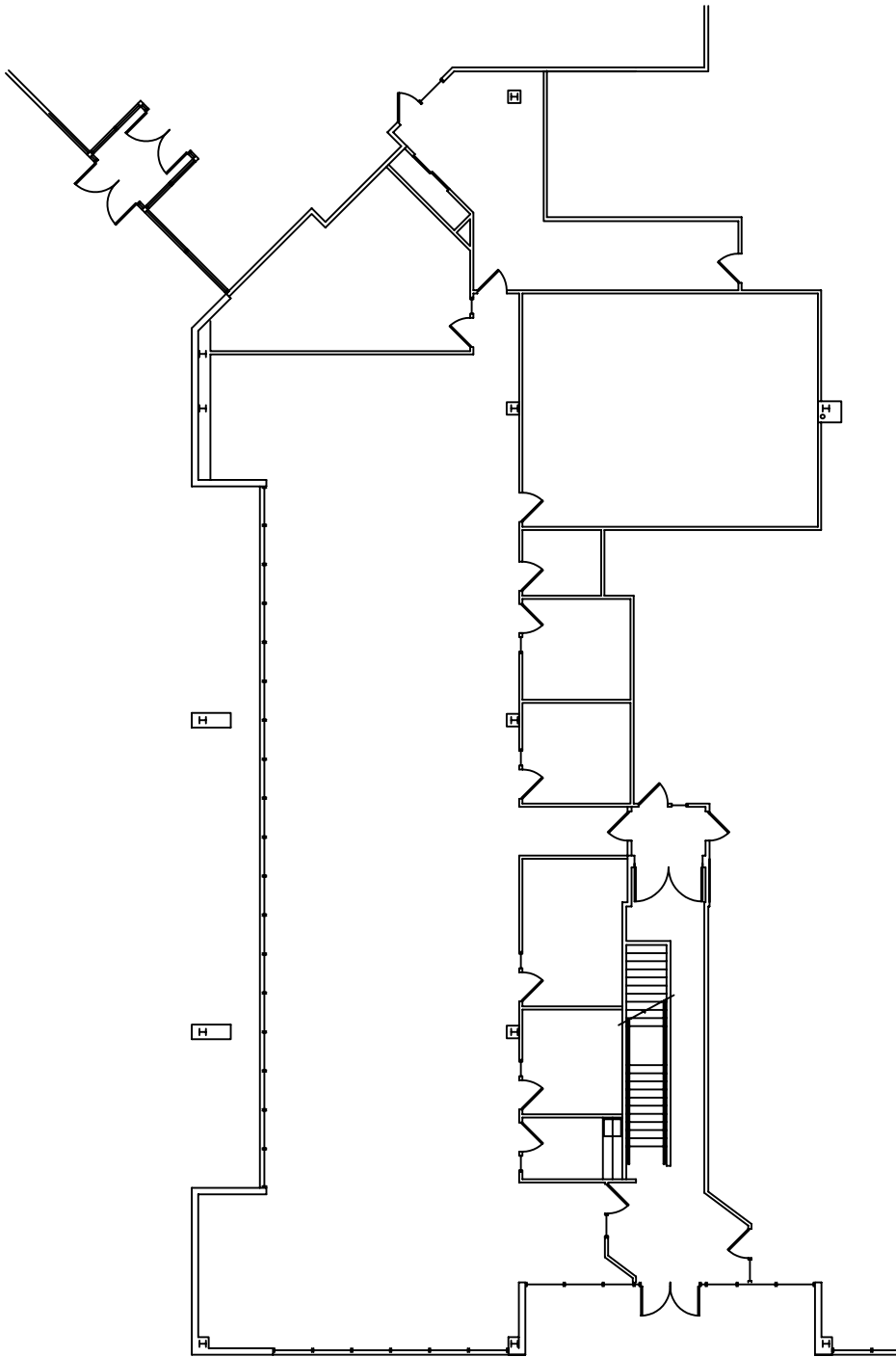

## North East Business Campus 3700 Corporate Drive - Suite 160

Building 5

Columbus, Ohio 43231

6,302 Sq. Ft. Available



614 .365.9000  
614 .280.0244 (fax)

[www.AlterraRE.com](http://www.AlterraRE.com)