

3700 Corporate Drive
Columbus, OH 43228

For Lease



Office space perfectly suited for your business

Lease Rates:

\$9.95 - \$11.95 psf NNN

Available Space:

1st Floor 2,072 sf - 14,503 sf

2nd Floor 1,715 sf - 16,250 sf

- Immediate occupancy
- Flexible floor plans
- Exterior signage available (monument & building)
- Recently updated common areas
- Wooded setting with walking path
- Located off of SR 161 with easy access to I-670, I-270 and I-71
- Convenient to Easton Town Center and John Glenn International Airport

All the contained information has been compiled from sources deemed to be reliable, but no representation is made as to the accuracy thereof and it is submitted subject to errors and omissions. Buyer is responsible for verifying the information contained herein. The submission is also subject to changes in price, rental or other conditions, prior sale, lease or financing or withdrawal without notice.



Bradford L. Kitchen, SIOR
614.545.2155
bkitchen@AlterraRE.com

Alterra Real Estate
614.365.9000
www.AltterraRE.com

3700 Corporate Drive - AVAILABLE OFFICE SPACE - 1st FLOOR

Columbus, OH

Suite	RSF	Lease Rate/RSF	Comments
100	8,201	\$9.95 - \$11.95 NNN	Located directly off 1st floor lobby. Can be combined with Ste 160 for 14,503 SF
110	2,946	\$9.95 - \$11.95 NNN	6 offices incl corner office, conference room, break room. Can be combined with Ste 145 for 5,018 SF
145	2,072	\$9.95 - \$11.95 NNN	5 offices, reception, break room, open area and work room. Can be combined with Ste 110 for 5,018 SF
160	6,302	\$9.95 - \$11.95 NNN	Located directly off 1st floor lobby. Can be combined with Ste 100 for 14,503 SF

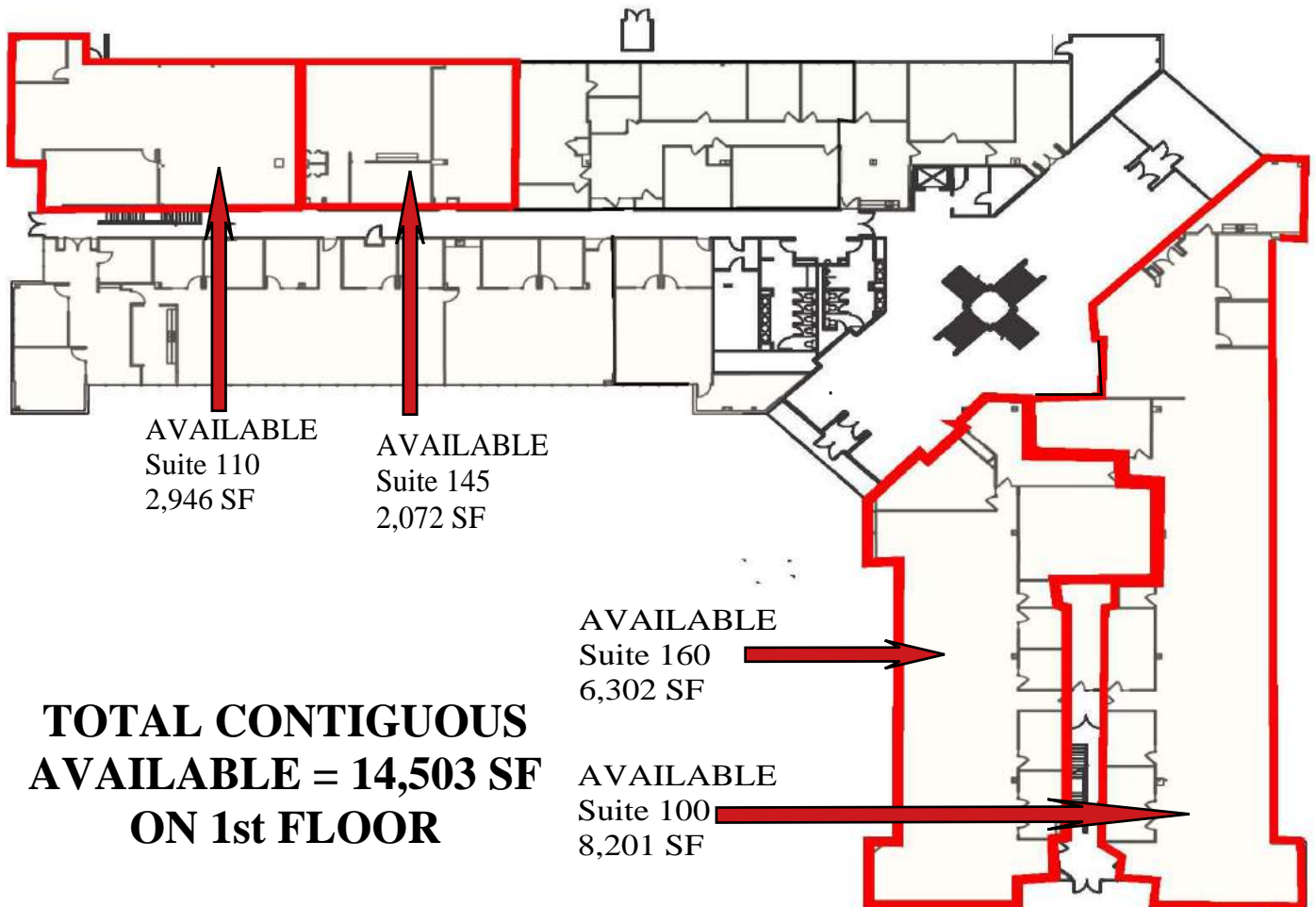

3700 Corporate Drive - AVAILABLE OFFICE SPACE - 2nd FLOOR
Columbus, OH

Suite	RSF	Lease Rate/RSF	Comments
200	14,535	\$9.95 - \$11.95 NNN	Located off 2nd floor lobby; windows; flexible floor plan; divisible
210	1,715	\$9.95 - \$11.95 NNN	Located off 2nd floor lobby; windows

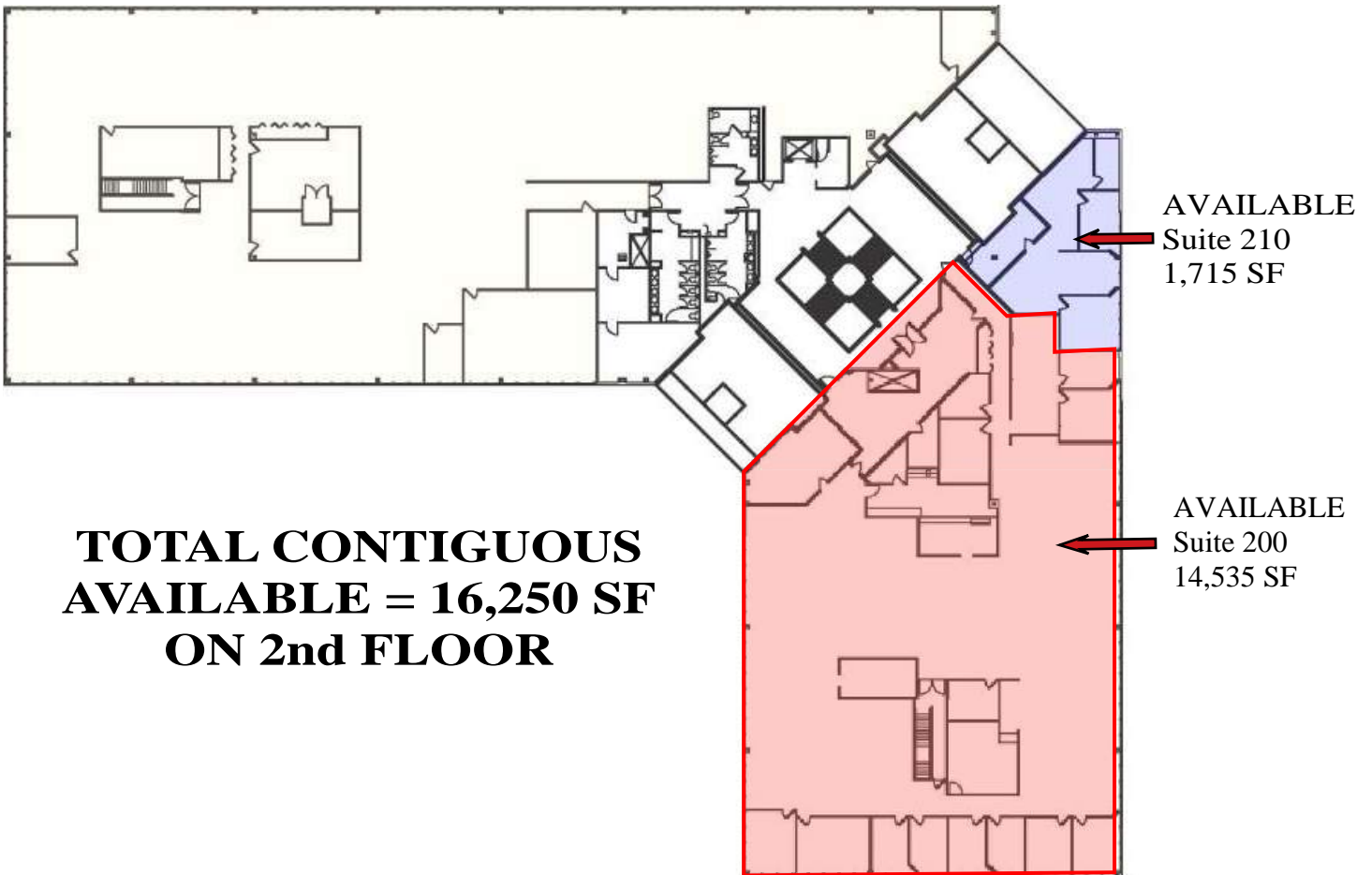

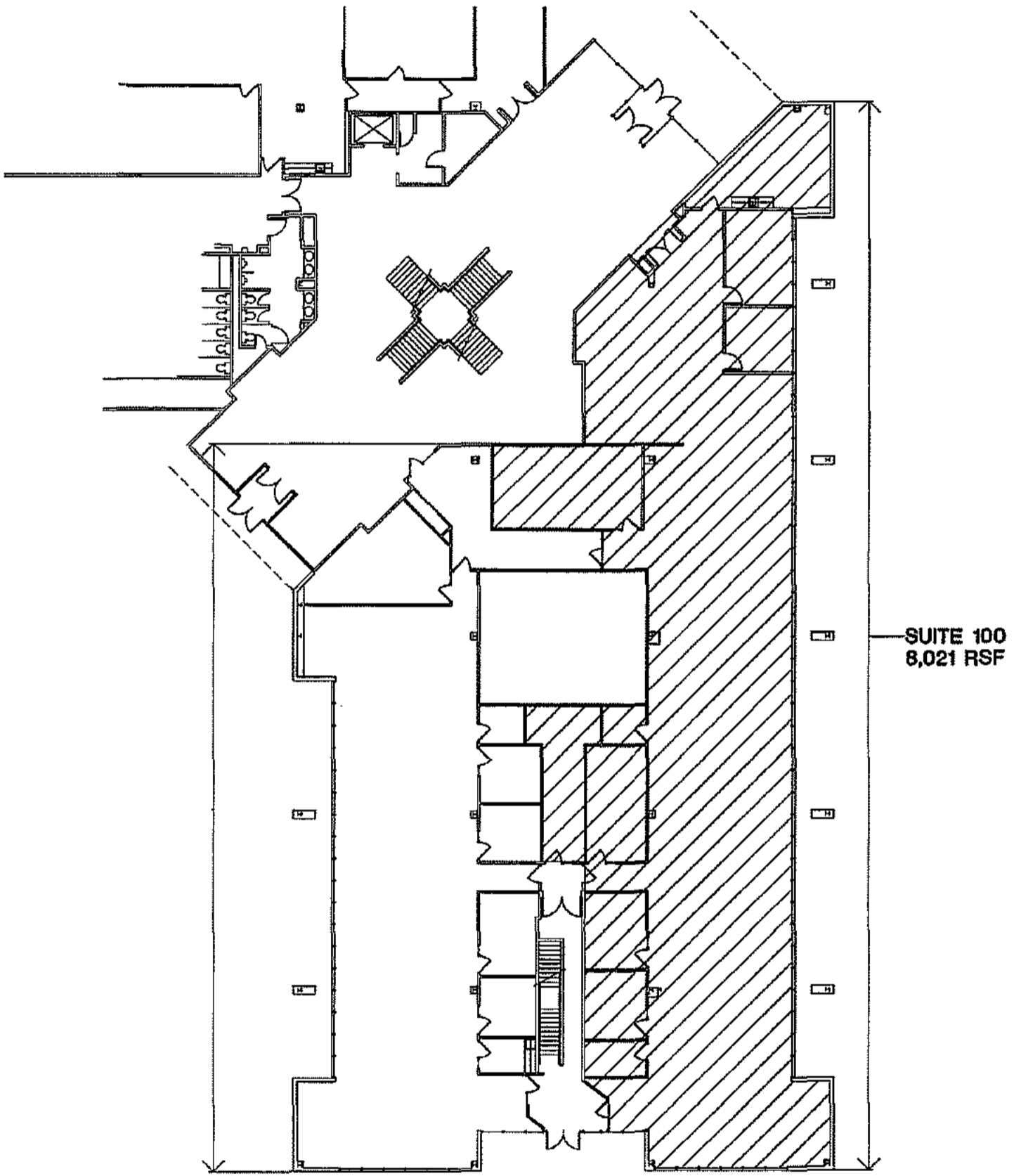

FIRST FLOOR - NEBC #5

Parking Area

Suite 110
2,946 SF

Entrance/Exit

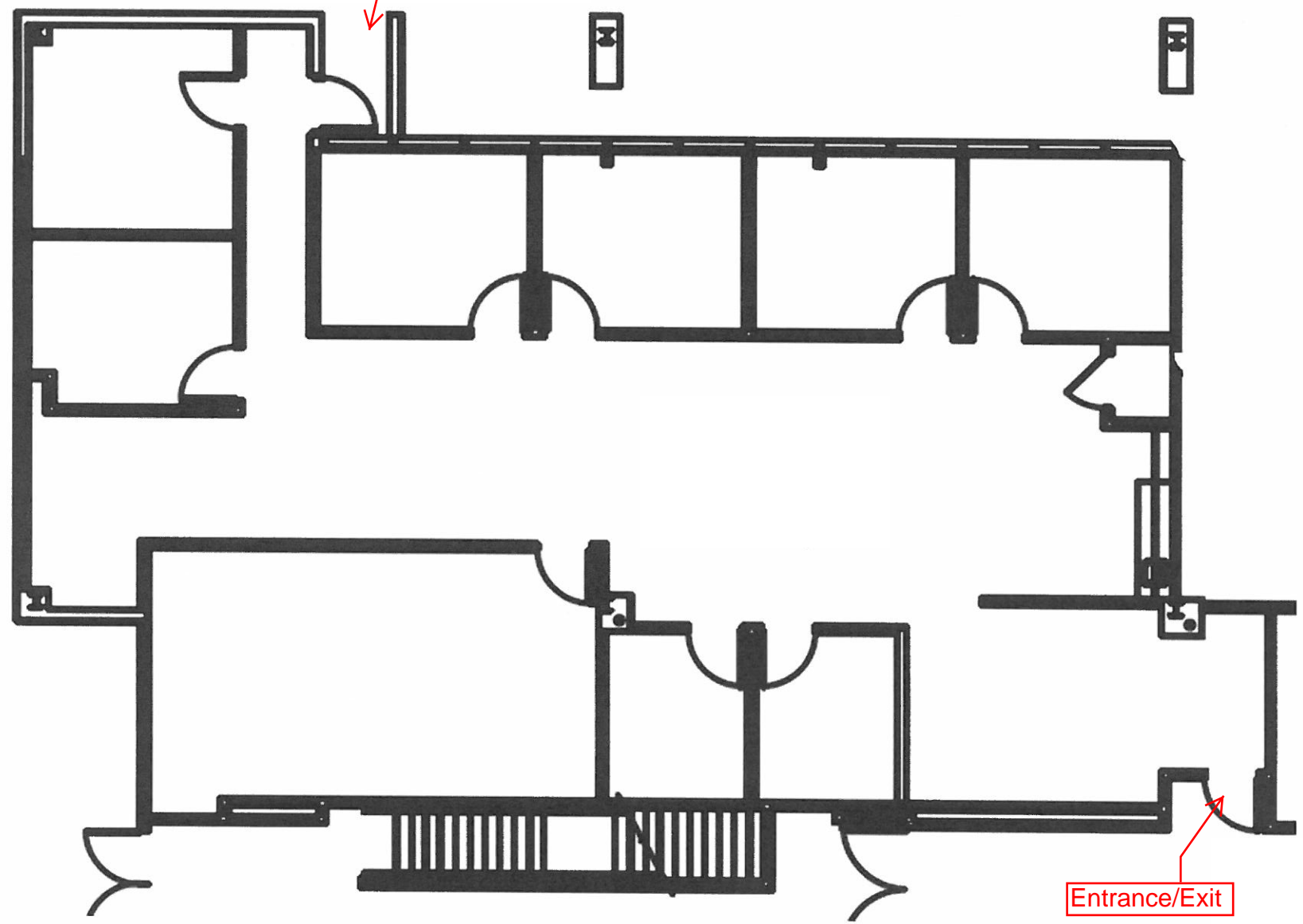

Entrance/Exit

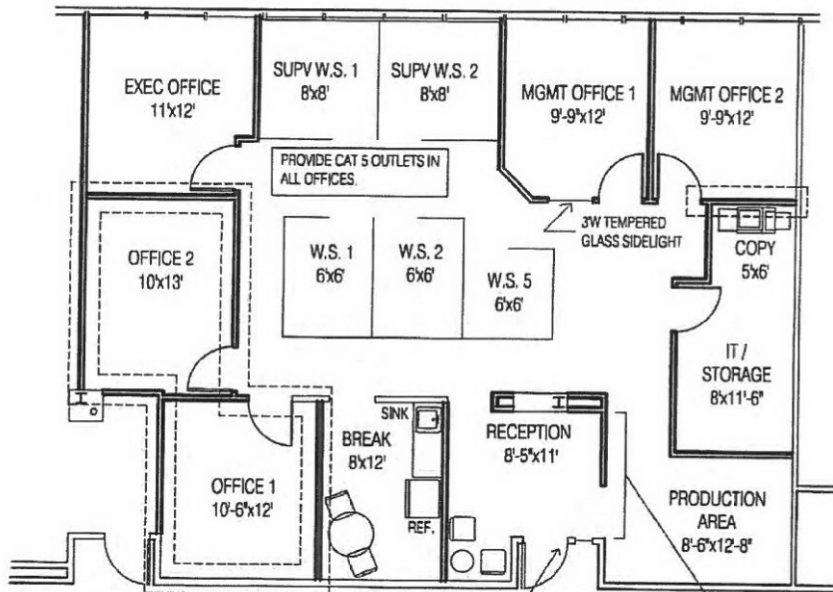

Suite 145
2,072 SF

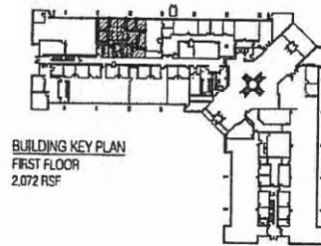

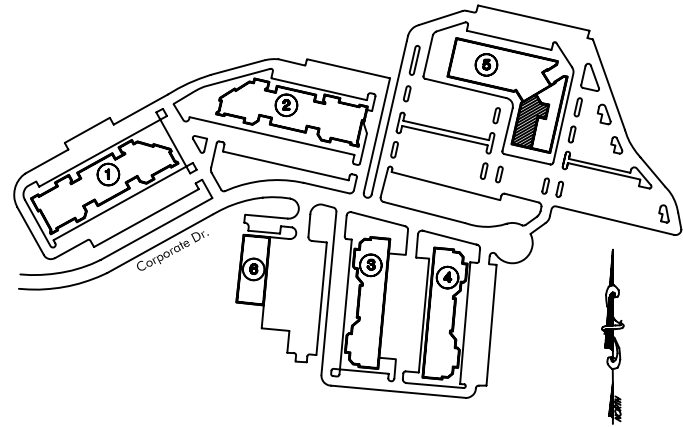
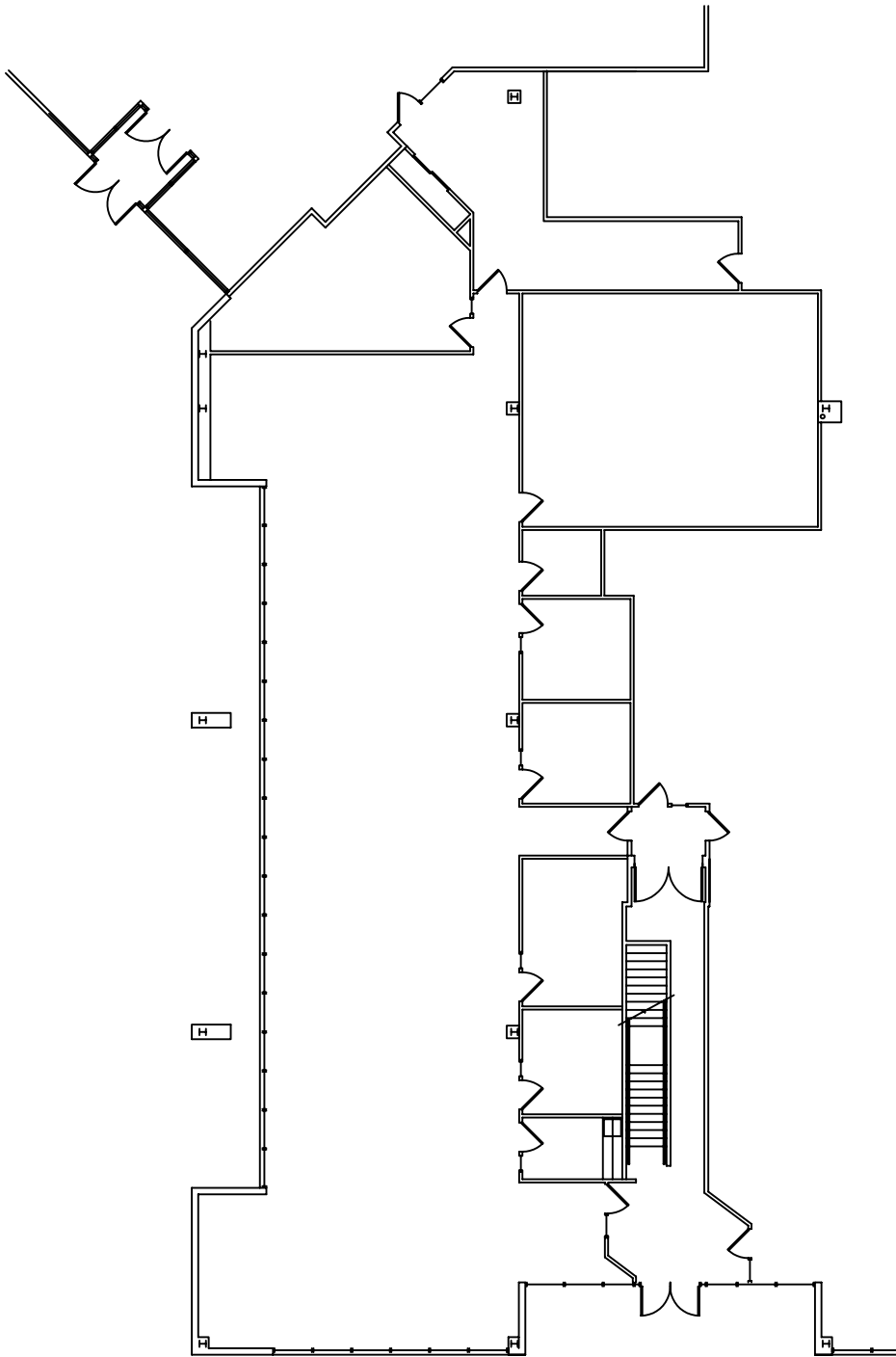

North East Business Campus 3700 Corporate Drive - Suite 160

Building 5

Columbus, Ohio 43231

6,302 Sq. Ft. Available



614 .365.9000
614 .280.0244 (fax)

www.AlterraRE.com